

1690 32nd Street NW– Birds Eye View



1690 32nd Street NW – Rear Window and Door Replacement.

Description of Work: Work in rear of residence. Replacing a current 3 panel sliding door with a New four panel sliding door. Replacing double hung windows with new casement windows and Replacing small window with new awning window. The new windows and door all have no muntins for a cohesive design for the entire rear of home. The windows and door will be full frame replacement installed within the current masonry openings. We are proposing for the products to be aluminum clad.



1690 32nd Street NW – Full Rear View Closeup



1690 32nd Street NW – Close up of Current Sliding Door

Close up of sliding door being replaced with new four panel sliding door with no grids.
Current door is not original.



1690 32nd Street NW – Window Close up

Close up of 2nd floor windows. Double hung windows to be replaced with new casement windows. Small window to be replaced with awning window. No muntins on new windows.



Elevation drawing of proposed rear design 1690 32nd Street NW

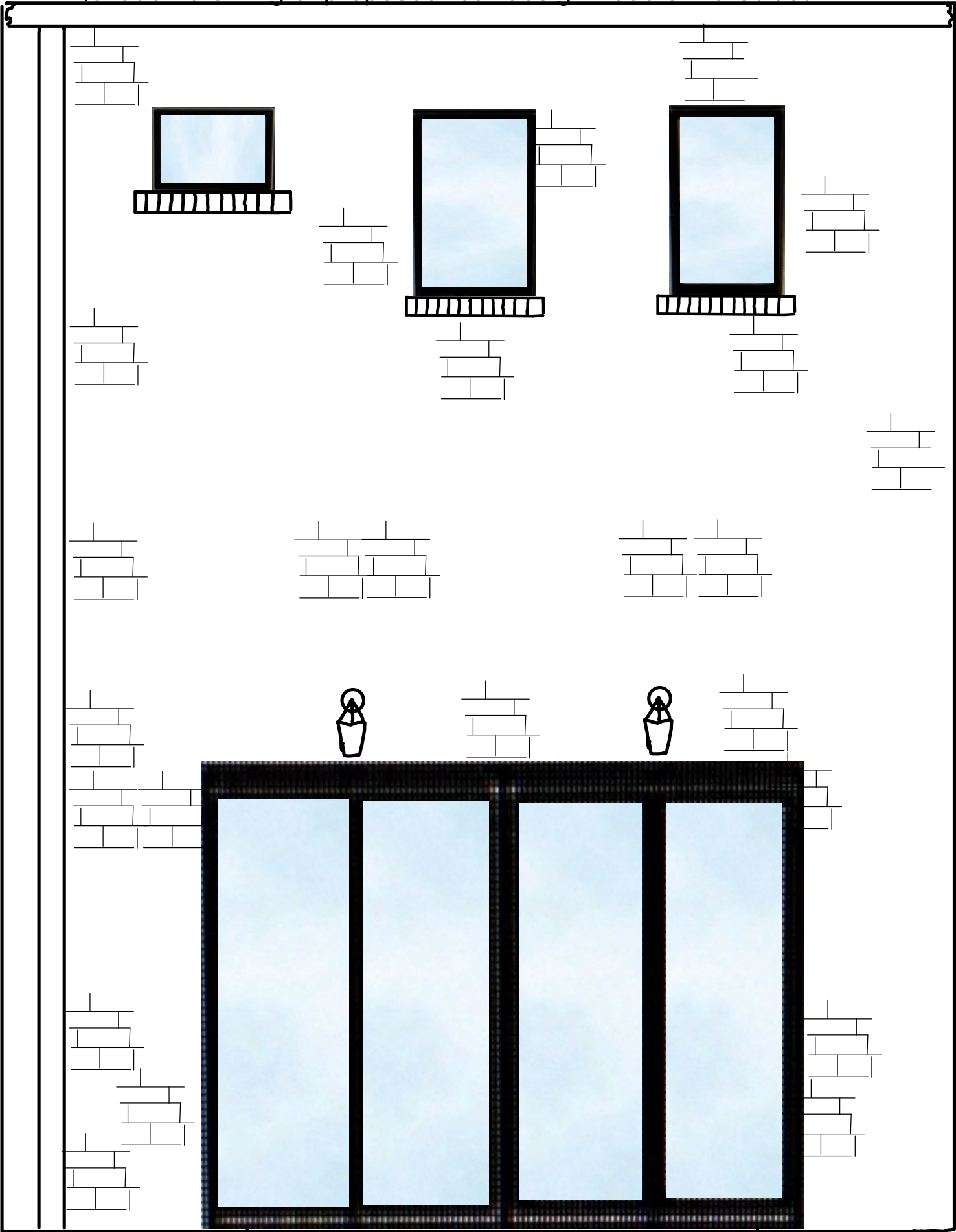



Proposal - Detailed

Pella Window and Door Showroom of Tysons Corner
 8150 Leesburg Pike Suite 140
 Vienna, VA 22182
Phone: (301) 354-3689 **Fax:**

Sales Rep Name: Lage, David
Sales Rep Phone: 301-957-7000
Sales Rep E-Mail: dlage@pellamidatlantic.com
Sales Rep Fax:

Customer Information	Project/Delivery Address	Order Information
Joseph Rafidi 1690 32nd St NW Washington, DC 20007-2969 Primary Phone: (818) 9263800 Mobile Phone: Fax Number: E-Mail: jfidi731@gmail.com Contact Name: Great Plains #: 1006169971 Customer Number: 1010006915 Customer Account: 1006169971	*Joseph Rafidi - 1690 32Nd St NW, Washington, DC, 1690 32Nd St NW Lot # Washington, DC 20007 County: Owner Name: Joseph Rafidi Owner Phone: (818) 9263800	Quote Name: *Joseph Rafidi - 1690 32Nd St NW, Washington, DC, Order Number: 7178GGGXP Quote Number: 13890113 Order Type: Installed Sales Wall Depth: Payment Terms: DC-EXEMPT Tax Code: None Cust Delivery Date: 4/2/2021 Quoted Date: 4/7/2021 Contracted Date: Booked Date: Customer PO #:

Line #	Location:	Attributes	Qty
10	Sliding Door	Lifestyle, Quad Sliding Door, Contemporary, , Fixed / Vent Left / Vent Right / Fixed, Without HGP, White 1: Fixed / Vent Left / Vent Right / Fixed Quad Sliding Door General Information: No Package, Without Hinged Glass Panel, Clad, Pine, 5 7/8", 4 9/16", No Certification, Oak Threshold Exterior Color / Finish: Standard Enduraclad, White Interior Color / Finish: Bright White Paint Interior Glass: Insulated Tempered Low-E Advanced Low-E Insulating Glass Argon Non High Altitude Hardware Options: Black, Standard, Handle Included, Handle Included, Satin Nickel, White, No Integrated Sensor Screen: No Screen, Champagne Performance Information: U-Factor 0.28, SHGC 0.28, VLT 0.52, CPD PEL-N-230-00076-00001, Performance Class R, PG 20, Calculated Positive DP Rating 20, Calculated Negative DP Rating 20, Year Rated 08 11 Grille: No Grille.	1

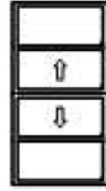

PK #
2095

Viewed From Exterior

PSPAINTRR22 - PAINTRR22 Paint Trim to Match Pella Pre-Finished Entry Syste Qty 2
RIW236 - Sliding Door Insallation - over 9' wide (Assembly Included) Qty 1

Line #		Location:		Attributes		Qty
15		Awning		Lifestyle, Awning, Vent, Without HGP, White		1
	PK #					
	2095					
	Viewed From Exterior					
<p>1: SizeNon-Standard Size Vent Awning General Information: No Package, Without Hinged Glass Panel, Clad, Pine, 5", 3 11/16", No Certification Exterior Color / Finish: Standard Enduraclad, White Interior Color / Finish: Bright White Paint Interior Glass: Insulated Low-E Advanced Low-E Insulating Glass Argon Non High Altitude Hardware Options: Wash Hinge Hardware, Fold-Away Crank, White, No Limited Opening Hardware, No Integrated Sensor, Sill Screen: Full Screen, Bright White, InView™ Performance Information: U-Factor 0.29, SHGC 0.27, VLT 0.51, CPD PEL-N-37-00714-00001, Performance Class LC, PG 30, Calculated Positive DP Rating 30, Calculated Negative DP Rating 30, Year Rated 08 11, Egress Not Applicable Grille: No Grille,</p>						
RIW210 - Full Tear Out Installation - Single Unit						

Line #		Location:		Attributes		Qty
20		Office		Lifestyle, Casement Left, Without HGP, White		2
	PK #					
	2095					
	Viewed From Exterior					
<p>1: SizeNon-Standard Size Left Casement General Information: No Package, Without Hinged Glass Panel, Clad, Pine, 5", 3 11/16", No Certification Exterior Color / Finish: Standard Enduraclad, White Interior Color / Finish: Bright White Paint Interior Glass: Insulated Low-E Advanced Low-E Insulating Glass Argon Non High Altitude Hardware Options: Wash Hinge Hardware, Fold-Away Crank, White, No Limited Opening Hardware, No Integrated Sensor Screen: Full Screen, Bright White, InView™ Performance Information: U-Factor 0.29, SHGC 0.27, VLT 0.51, CPD PEL-N-14-00677-00001, Performance Class LC, PG 45, Calculated Positive DP Rating 45, Calculated Negative DP Rating 45, Year Rated 08 11, Clear Opening Width 25.25, Clear Opening Height 48.875, Clear Opening Area 8.570095, Egress Meets Typical 5.7 sqft (E) (United States Only) Grille: No Grille,</p>						
RIW210 - Full Tear Out Installation - Single Unit						

Thank You For Your Interest In Pella® Products

PELLA WARRANTY:

Pella products are covered by Pella's limited warranties in effect at the time of sale. All applicable product warranties are incorporated into and become a part of this contract. Please see the warranties for complete details, taking special note of the two important notice sections regarding installation of Pella products and proper management of moisture within the wall system. Neither Pella Corporation nor the Seller will be bound by any other warranty unless specifically set out in this contract. However, Pella Corporation will not be liable for branch warranties which create obligations in addition to or obligations which are inconsistent with Pella written warranties.

Clear opening (egress) information does not take into consideration the addition of a Rolscreen [or any other accessory] to the product. You should consult your local building code to ensure your Pella products meet local egress requirements.

Per the manufacturer's limited warranty, unfinished mahogany exterior windows and doors must be finished upon receipt prior to installing and refinished annually, thereafter. Variations in wood grain, color, texture or natural characteristics are not covered under the limited warranty.

INSYNCTIVE PRODUCTS: In addition, Pella Insynctive Products are covered by the Pella Insynctive Products Software License Agreement and Pella Insynctive Products Privacy Policy in effect at the time of sale, which can be found at [Insynctive.pella.com](https://www.pella.com). By installing or using Your Insynctive Products you are acknowledging the Insynctive Software Agreement and Privacy Policy are part of the terms of sale.

Notice of Collection of Personal Information: We may collect your personal information when you interact with us. Under the California Consumer Privacy Act (CCPA), California residents have specific rights to request this information, request to delete this information, and opt out of the sharing or sale of this information to third parties. To learn more about our collection practices and your rights under the CCPA please visit our link <https://www.pella.com/california-rights-policy> at [pella.com](https://www.pella.com).

ARBITRATION AND CLASS ACTION WAIVER ("ARBITRATION AGREEMENT")

YOU and Pella and its subsidiaries and the Pella Branded Distributor AGREE TO ARBITRATE DISPUTES ARISING OUT OF OR RELATING TO YOUR PELLA PRODUCTS (INCLUDES PELLA GOODS AND PELLA SERVICES) AND WAIVE THE RIGHT TO HAVE A COURT OR JURY DECIDE DISPUTES. YOU WAIVE ALL RIGHTS TO PROCEED AS A MEMBER OR REPRESENTATIVE OF A CLASS ACTION, INCLUDING CLASS ARBITRATION, REGARDING DISPUTES ARISING OUT OF OR RELATING TO YOUR PELLA PRODUCTS. You may opt out of this Arbitration Agreement by providing notice to Pella no later than ninety (90) calendar days from the date You purchased or otherwise took ownership of Your Pella Goods. To opt out, You must send notice by e-mail to pellawebsupport@pella.com, with the subject line: "Arbitration Opt Out" or by calling (877) 473-5527. Opting out of the Arbitration Agreement will not affect the coverage provided by any applicable limited warranty pertaining to Your Pella Products. For complete information, including the full terms and conditions of this Arbitration Agreement, which are incorporated herein by reference, please visit www.pella.com/arbitration or e-mail to pellawebsupport@pella.com, with the subject line: "Arbitration Details" or call (877) 473-5527. D'ARBITRAGE ET RENONCIATION AU RECOURS COLLECTIF ("convention d'arbitrage") EN FRANÇAIS SEE PELLA.COM/ARBITRATION. DE ARBITRAJE Y RENUNCIA COLECTIVA ("acuerdo de arbitraje") EN ESPAÑOL VER PELLA.COM/ARBITRATION.

Seller shall not be held liable for failure or delay in the performance of its obligations under this Agreement, if such performance is hindered or delayed by the occurrence of an act or event beyond the Seller's reasonable control (force majeure event), including but not limited to earthquakes, unusually severe weather and other Acts of God, fire, strikes and labor unrest, epidemics, riots, war, civil unrest, and government interventions. Seller shall give timely notice of a force majeure event and take such reasonable action to mitigate the impacts of such an event.

Product Performance Information:

U-Factor, Solar Heat Gain Coefficient (SHGC), and Visible Light Transmittance (VLT) are certified by the National Fenestration Rating Council (NFRC).

For more information regarding the finishing, maintenance, service and warranty of all Pella® products, visit the Pella® website at www.pella.com

Manufacturer stipulates that these ratings conform to applicable NFRC procedures for determining whole product performance. NFRC ratings are determined for a fixed set of environmental conditions and a specific product size. NFRC does not recommend any products and does not warrant the suitability of any product for any specific use.

Design Pressure (DP), Performance Class, and Performance Grade (PG) are certified by a third party organization, in many cases the Window and Door Manufacturers Association (WDMA). The certification requires the performance of at least one product of the product line to be tested in accordance with the applicable performance standards and verified by an independent party. The certification indicates that the product(s) of the product line passed the applicable tests. The certification does not apply to mulled and/or product combinations unless noted. Actual product results will vary and change over the products life.

For more performance information along with information on Florida Product Approval System (FPAS) Number and Texas Dept. of Insurance (TDI) number go to www.pella.com/performance.

TERMS & CONDITIONS:

Pella Mid-Atlantic, Inc.

QUOTE:

Due to unprecedented volatility in the market, home improvement materials pricing, due in part to supply chain shortages of resin, metals and other items, this quote is subject to change based on increases from Pella Corporation and our other suppliers. In turn, The quoted price is valid for 7 days. As a valued customer we will do our very best to honor the original pricing but based on circumstances out of our control, this may not be always possible. The seller will not be responsible for delays due to labor troubles, fire, accidents, transportation, or other causes beyond its control.



Architect Series® Traditional Casement Window

Unit Sections - Aluminum-Clad Exterior, Ogee Exterior Profile

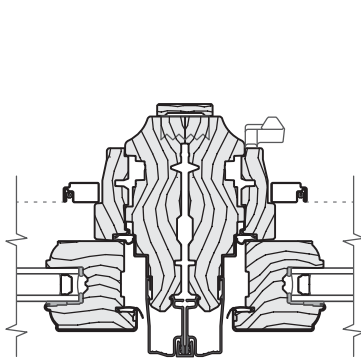
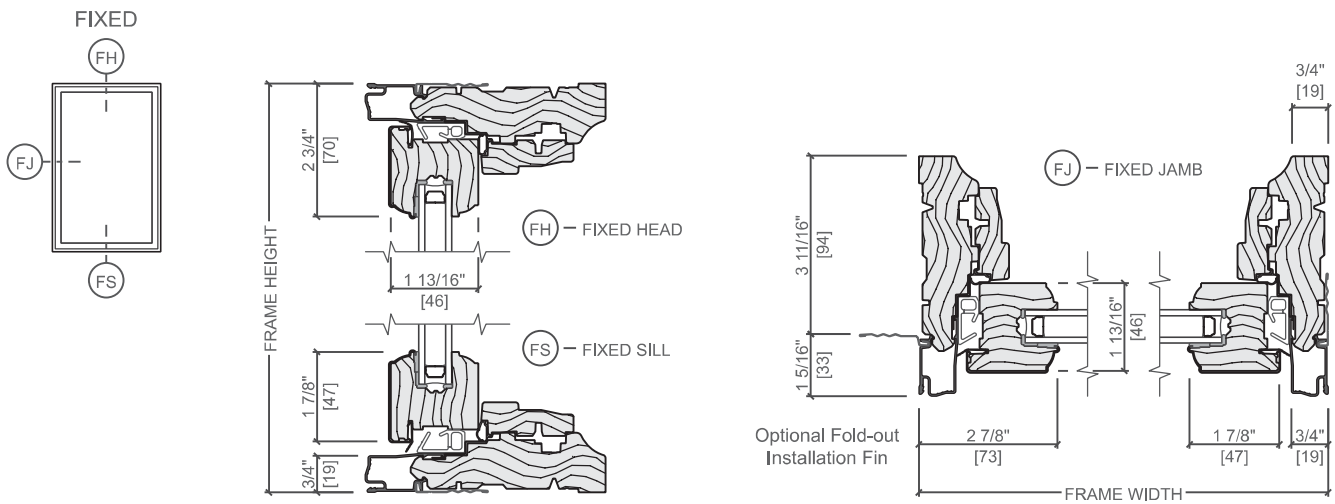
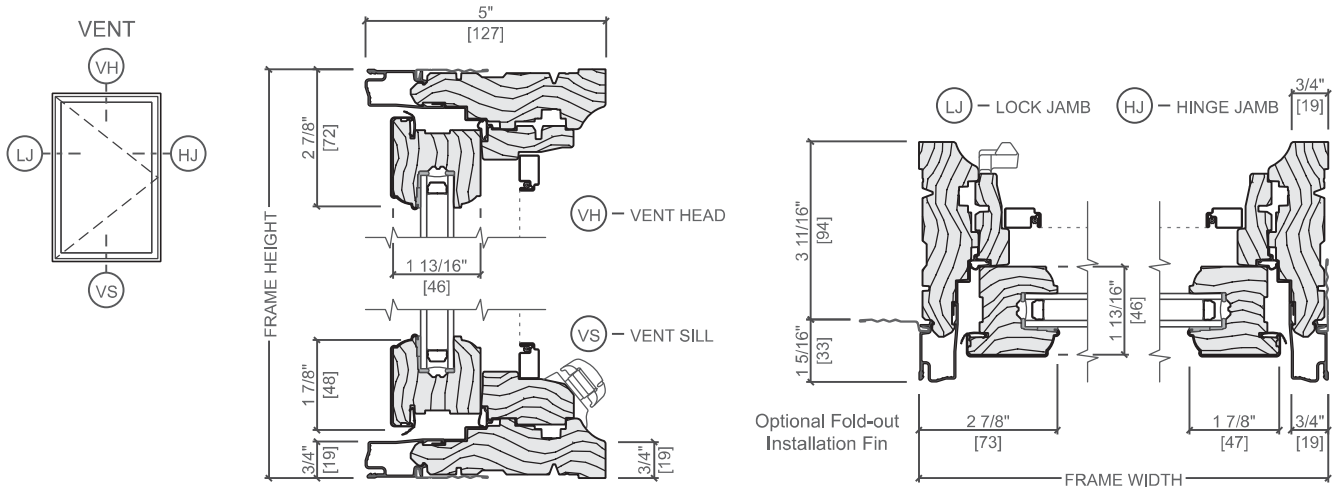

VERTICAL JOINING MULLION
VENT / VENT

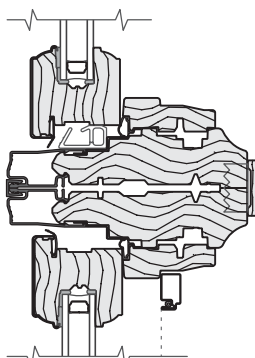

HORIZONTAL JOINING MULLION
TRANSOM / VENT

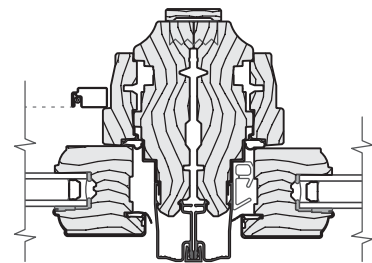

VERTICAL JOINING MULLION
VENT / FIXED

Scale 3" = 1' 0"

All dimensions are approximate.

See Combinations Section for mullion limitations and reinforcing requirements.